

# 丈量図 7/17

(才) 奈良市中山町68番1

S=1/500

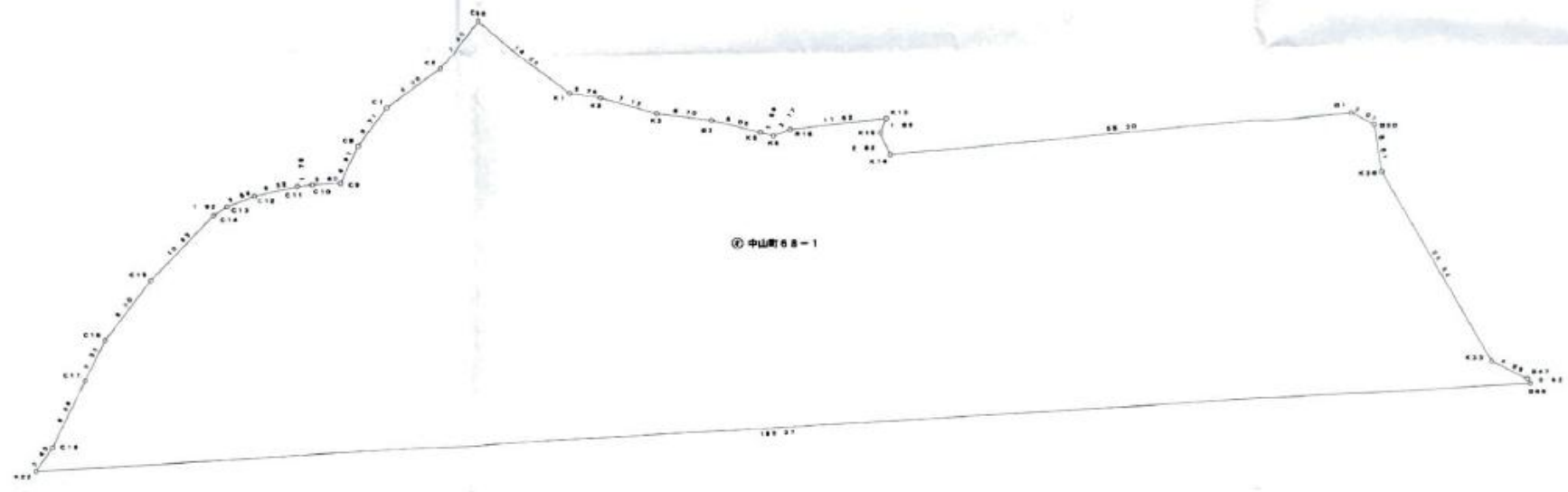

中山町68-1

求積表

地番	NO	$X_n$	$Y_n$	$Y_{n+1} - Y_{n-1}$	$X_n \cdot (Y_{n+1} - Y_{n-1})$
中山町68-1	C90	-143415.118	-21207.376	-16.159	2317444.891762
	C2	-143421.100	-21212.322	-11.387	1633136.748920
	C1	-143426.069	-21218.763	-9.885	1417766.098965
	C8	-143430.970	-21222.207	-5.962	797760.830340
	C9	-143435.067	-21224.325	-5.517	791330.933619
	C10	-143435.180	-21227.724	-5.174	742133.662364
	C11	-143435.360	-21229.499	-4.984	1001752.554210
	C12	-143436.471	-21234.708	-8.537	1224517.192927
	C13	-143437.699	-21238.036	-4.954	710590.369846
	C14	-143438.733	-21239.662	-9.301	1338123.633633
	C15	-143440.394	-21247.337	-13.250	1900664.588000
	C16	-143443.454	-21252.912	-7.997	1147197.271638
	C17	-143448.283	-21256.334	6.371	913972.211313
	C18	-143446.170	-21259.283	-5.950	853623.711590
	K22	-143468.962	-21261.284	178.096	-25651248.256352
	B46	-143459.034	-21061.187	179.781	-25791208.591554
	B47	-143438.499	-21061.103	-4.525	649148.701975
	K33	-143436.412	-21065.712	-17.337	2487193.814844

K35	-143434.147	-21098.840	-14.078	2019265.921466
B50	-143428.618	-21099.790	-3.606	117293.096208
B1	-143427.201	-21102.446	-57.774	8286363.116574
K14	-143431.731	-21157.964	-56.296	8068896.409136
K15	-143429.148	-21158.702	-0.394	56511.064312
K13	-143427.418	-21157.958	19.821	1522028.090178
K15	-143428.623	-21169.523	-13.607	1861633.273164
K6	-143429.374	-21171.960	-3.383	517907.447042
K5	-143428.960	-21173.106	-7.406	1062234.877760
K3	-143427.454	-21178.971	-12.502	1793130.029808
K3	-143426.535	-21185.608	13.472	1932242.279620
K2	-143424.506	-21192.443	19.555	1513845.660830
K1	-143423.929	-21196.163	14.933	2141748.531757
合計				11178.300868
面積				5589.1504340
縮尺				1089.15 * 2

図面名称	丈量図 (才)奈良市中山町68番1		
所在	奈良市中山町68番1		
図番	7/17	縮尺	1/500
平成20年3月11日 作成			
測量・作成者 奈良市役所第10番10号 三和マンションB-517 土地家屋調査士 中島 俊一			

# 丈量

(才) 奈良市中

S = 1 / 5

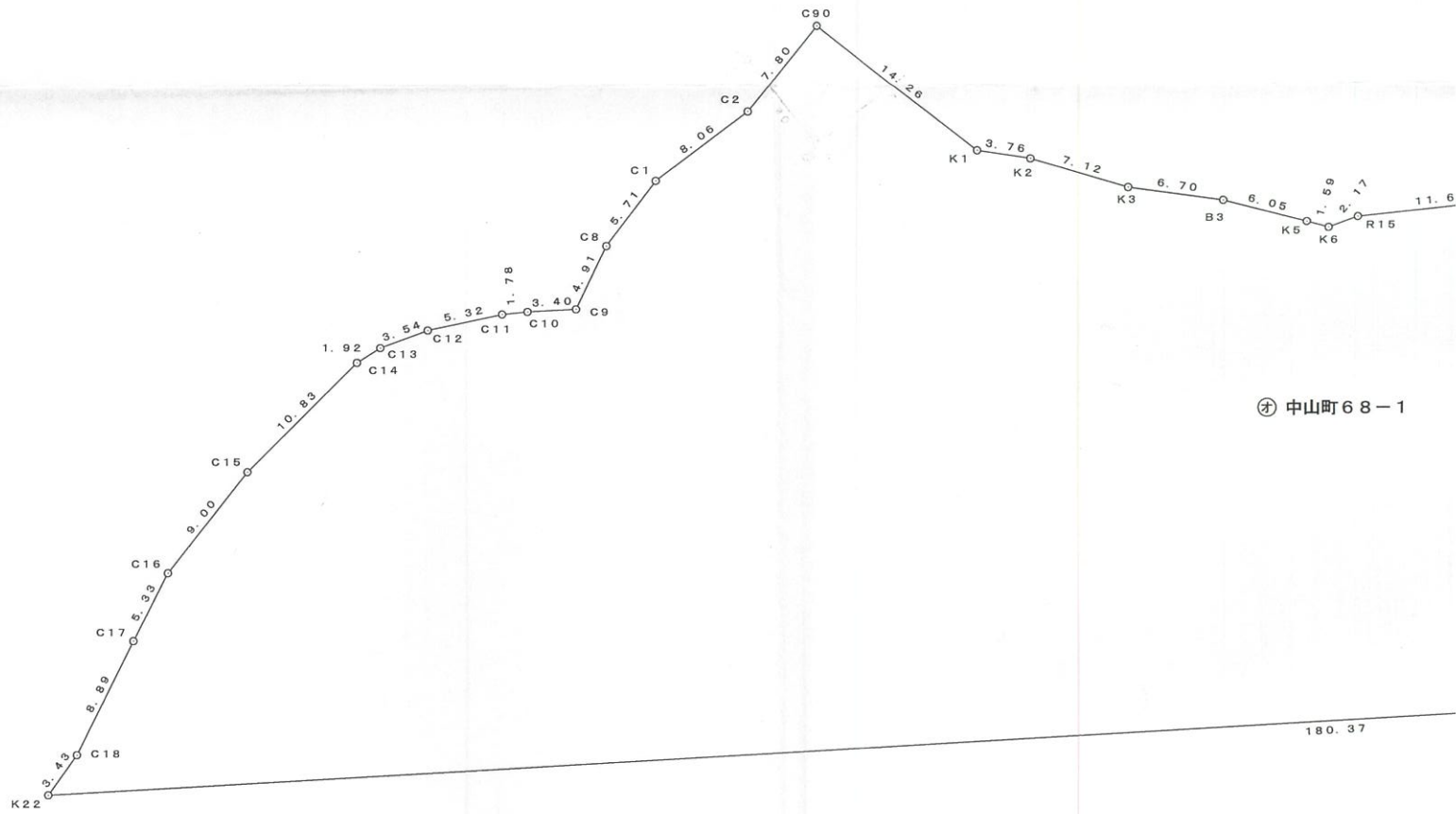

⊕ 中山町68-1

求積表

地番	⊕ 中山町68-1			
NO	$X_n$	$Y_n$	$Y_{n+1} - Y_{n-1}$	$X_n \cdot (Y_{n+1} - Y_{n-1})$
C90	-143415.118	-21207.376	-16.159	2317444.891762
C2	-143421.160	-21212.322	-11.387	1633136.748920
C1	-143426.009	-21218.763	-9.885	1417766.098965
C8	-143430.570	-21222.207	-5.562	797760.830340
C9	-143435.007	-21224.325	-5.517	791330.933619
C10	-143435.186	-21227.724	-5.174	742133.652364
C11	-143435.360	-21229.499	-6.984	1001752.554240
C12	-143436.471	-21234.708	-8.537	1224517.152927
C13	-143437.699	-21238.036	-4.954	710590.360846
C14	-143438.733	-21239.662	-9.301	1334123.655633
C15	-143446.384	-21247.337	-13.250	1900664.588000
C16	-143453.454	-21252.912	-7.997	1147197.271638
C17	-143458.203	-21255.334	-6.371	913972.211313
C18	-143466.170	-21259.283	-5.950	853623.711500
K22	-143468.962	-21261.284	178.096	-25551248.256352
B46	-143459.034	-21081.187	179.781	-25791208.591554
B47	-143458.499	-21081.503	-4.525	649149.707975
K33	-143456.412	-21085.712	-17.337	2487103.814844

# 丈量図

7/17

奈良市中山町68番1

縮尺 1/500

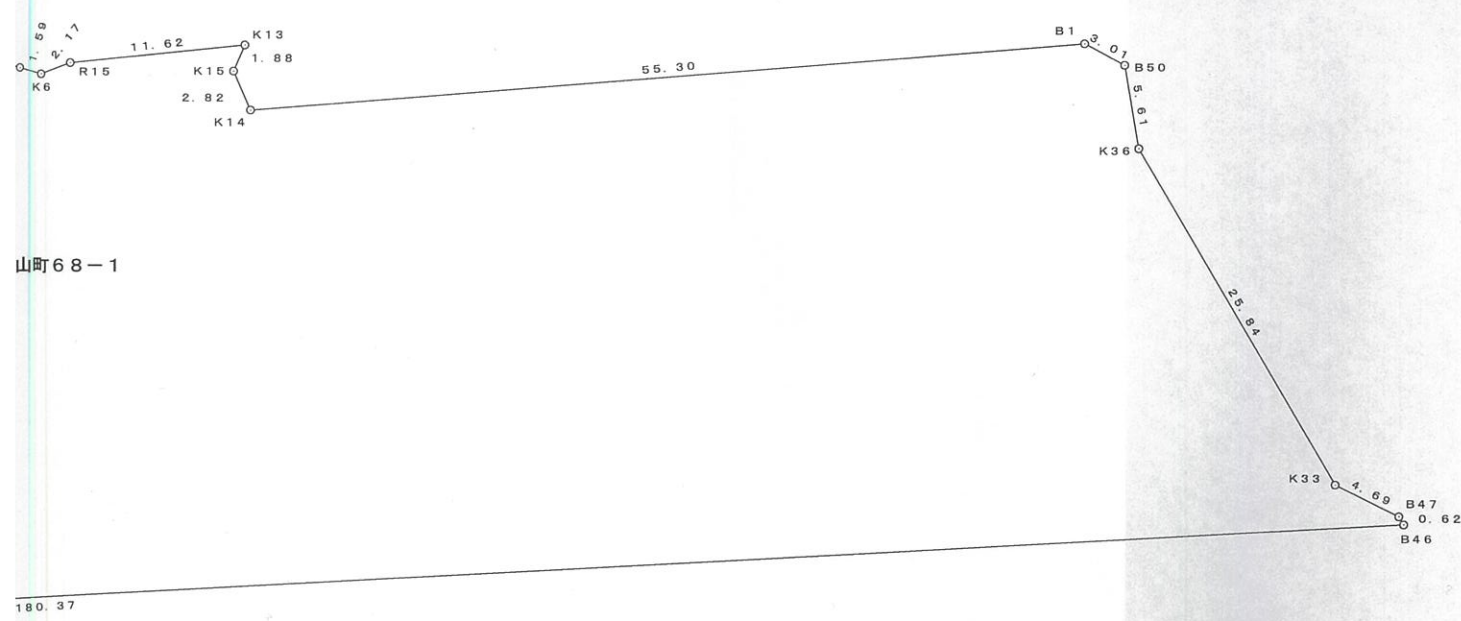

山町68-1

0					
1					
2					
3					
4					
5					
6					
7					
8					
9					
10					
11					
12					
13					
14					
15					
16					
17					
18					
19					
20					
21					
22					
23					
24					
25					
26					
27					
28					
29					
30					
31					
32					
33					
34					
35					
36					
37					
38					
39					
40					
41					
42					
43					
44					
45					
46					
47					
48					
49					
50					
51					
52					
53					
54					
55					
56					
57					
58					
59					
60					
61					
62					
63					
64					
65					
66					
67					
68					
69					
70					
71					
72					
73					
74					
75					
76					
77					
78					
79					
80					
81					
82					
83					
84					
85					
86					
87					
88					
89					
90					
91					
92					
93					
94					
95					
96					
97					
98					
99					
100					
101					
102					
103					
104					
105					
106					
107					
108					
109					
110					
111					
112					
113					
114					
115					
116					
117					
118					
119					
120					
121					
122					
123					
124					
125					
126					
127					
128					
129					
130					
131					
132					
133					
134					
135					
136					
137					
138					
139					
140					
141					
142					
143					
144					
145					
146					
147					
148					
149					
150					
151					
152					
153					
154					
155					
156					
157					
158					
159					
160					
161					
162					
163					
164					
165					
166					
167					
168					
169					
170					
171					
172					
173					
174					
175					
176					
177					
178					
179					
180					
181					
182					
183					
184					
185					
186					
187					
188					
189					
190					
191					
192					
193					
194					
195					
196					
197					
198					
199					
200					
201					
202					
203					
204					
205					
206					
207					
208					
209					
210					
211					
212					
213					
214					
215					
216					
217					
218					
219					
220					
221					
222					
223					
224					
225					
226					
227					
228					
229					
230					
231					
232					
233					
234					
235					
236					
237					
238					
239					
240					
241					
242					
243					
244					
245					
246					
247					
248					
249					
250					
251					
252					
253					
254					
255					
256					
257					
258					
259					
260					
261					
262					
263					
264					
265					
266					
267					
268					
269					
270					
271					
272					
273					
274					
275					
276					
277					
278					
279					
280					
281					
282					
283					
284					
285					
286					
287					
288					
289					
290					
291					
292					
293					
294					
295					
296					
297					
298					
299					
300					
301					
302					
303					
304					
305					
306					
307					
308					
309					
310					
311					
312					
313					
314					
315					
316					
317					
318					
319					
320					
321					
322					
323					
324					
325					
326					
327					
328					
329					
330					
331					
332					
333					
334					
335					
336					
337					
338					
339					
340					
341					
342					
343					
344					
345					
346					
347					
348					
349					
350					
351					
352					
353					
354					
355					
356					
357					
358					
359					
360					
361					
362					
363					
364</					

# 丈量図 8/17

(力) 奈良市中山町178番1

S=1/500

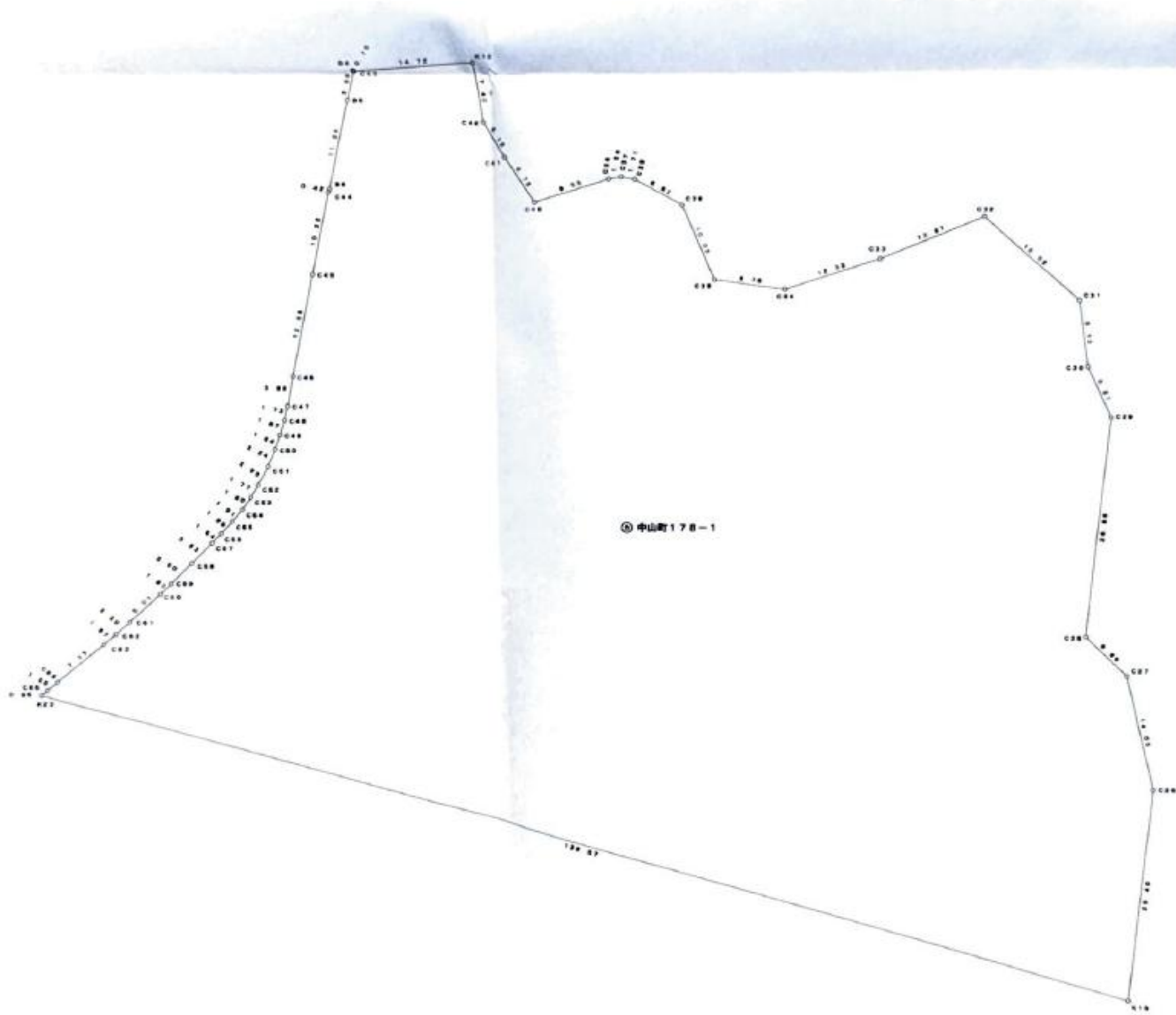

求積表

NO	X <sub>n</sub>	Y <sub>n</sub>	Y <sub>n</sub> -Y <sub>n-1</sub>	X <sub>n</sub> × (Y <sub>n</sub> -Y <sub>n-1</sub> )
B4	-14342.730	-21488.243	-0.754	109513.845720
B5	-14346.537	-21448.917	-2.807	402273.729359
B6	-14357.947	-21491.050	-2.291	329432.231817
C44	-14357.942	-21451.208	-2.097	300621.688254
C45	-14368.020	-21453.147	-4.404	631392.750900
C46	-14399.335	-21456.812	-3.166	453942.140910
C47	-14383.957	-21456.313	-1.077	154424.521689
C48	-14385.653	-21456.689	-0.959	137596.841227
C49	-14387.430	-21457.272	-1.199	171924.528570
C50	-14389.172	-21457.888	-1.461	209491.580292
C51	-14391.257	-21458.733	-2.106	301981.987242
C52	-14393.476	-21459.994	-2.183	313927.958128
C53	-14394.988	-21460.916	-1.953	289950.811564
C54	-14396.472	-21461.947	-2.298	325625.092656
C55	-14397.907	-21463.214	-2.630	377136.495410
C56	-14399.369	-21464.677	-2.435	349177.463615
C57	-14400.878	-21466.349	-3.666	517162.123668
C58	-14402.507	-21468.183	-5.049	734041.428913
C59	-14406.378	-21470.999	-3.942	569953.462276
C60	-14406.637	-21472.925	-5.034	721909.010638
C61	-14410.014	-21475.732	-5.361	768821.085054
C62	-14411.896	-21477.386	-3.196	445292.601930
C63	-14412.660	-21478.837	-7.013	1066209.809900
C64	-14417.191	-21484.401	-6.771	971077.800261
C65	-14418.167	-21485.608	-1.963	291529.861821
K23	-14418.754	-21486.364	132.781	-1904385.374874
K16	-14455.798	-21362.827	136.803	-19625183.533794
C26	-14430.529	-21349.561	0.199	28542.677261
C27	-14416.819	-21352.628	-8.063	1154935.643467
C28	-14412.054	-21357.614	-1.931	278928.676274
C29	-14385.360	-21354.559	0.170	-24375.511200
C30	-14379.189	-21357.444	-3.970	569215.380330
C31	-14371.128	-21358.529	-12.747	1827551.768616
C32	-14366.886	-21370.191	-24.485	3510191.293710
C33	-14366.030	-21382.914	-24.373	3422933.468190
C34	-14360.770	-21394.764	-20.435	2929761.249650
C35	-14358.616	-21403.449	-12.716	1823075.321066
C36	-14359.426	-21407.480	-9.866	1414384.195576
C39	-14356.302	-21413.315	-7.525	1078756.172550
C37	-14356.901	-21415.905	-3.229	462996.527229
C38	-14356.272	-21416.544	-10.650	1528607.928330
C40	-14359.995	-21425.968	-12.907	1850538.839145
C41	-14353.501	-21429.451	-6.564	949972.880644
C42	-14349.162	-21432.232	-4.007	574400.092134
K12	-14341.960	-21433.458	-15.921	2282145.733960
C43	-14342.753	-21448.153	-14.785	2119223.046655
合計				-17678.112733
面積				8537.5562665
地積				8537.55 m <sup>2</sup>

図面名称	丈量図 (力) 奈良市中山町178番1		
所在	奈良市中山町178番1		
図番	8/17	縮尺	1/500
平成20年3月11日 作成			
測量・作成者 奈良市秋篠原月町10番10号 三和マンションB-517 土地家屋調査士 中島 俊一			

# 丈量

(力) 奈良市中山

S = 1 / 5

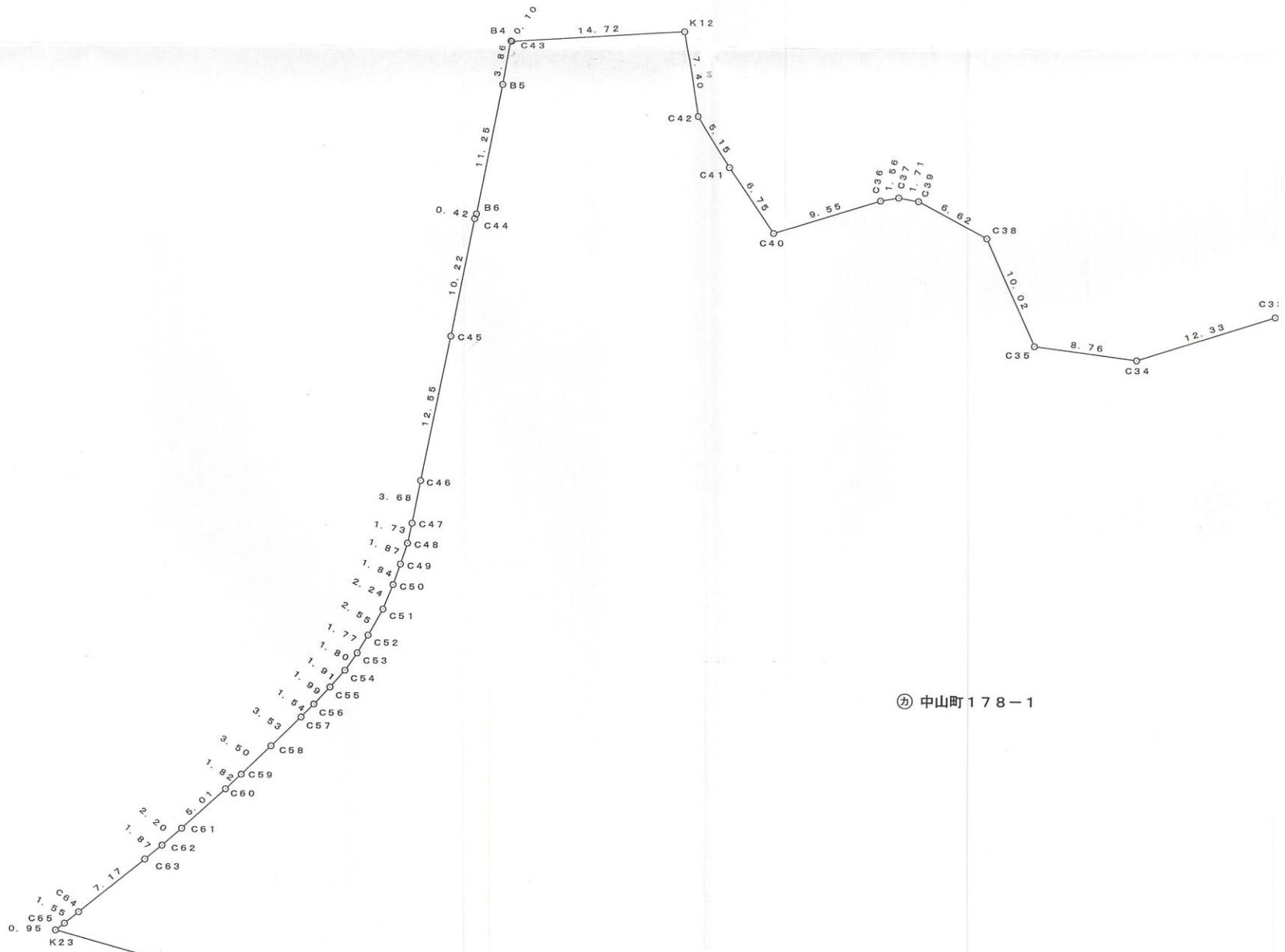

② 中山町178-1

138.57

# 丈量図

8 / 17

奈良市中山町178番1

1/500

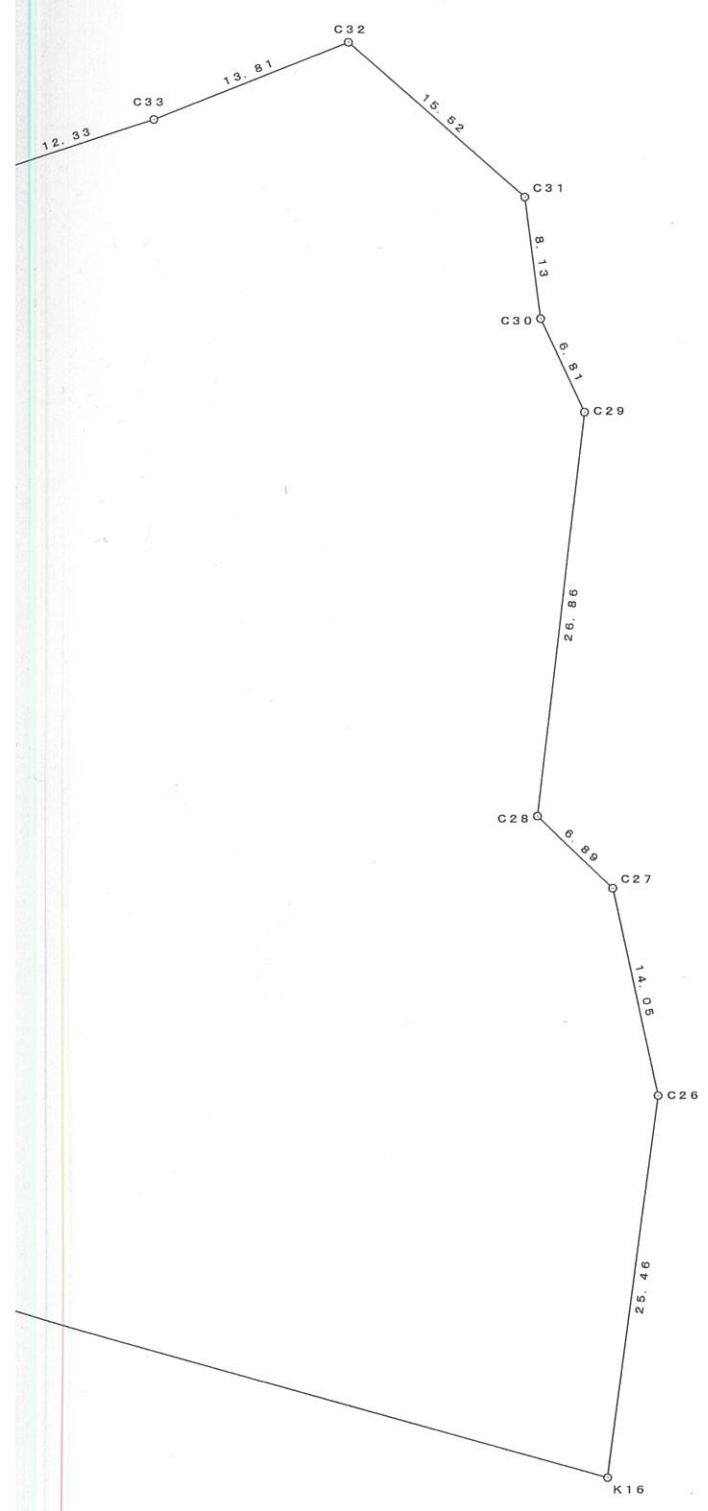

求積表

地番	② 中山町178-1				
NO	$X_n$	$Y_n$	$Y_{n+1} - Y_{n-1}$	$X_n \cdot (Y_{n+1} - Y_{n-1})$	
B4	-143342.730	-21448.243	-0.764	109513.845720	
B5	-143346.537	-21448.917	-2.807	402373.729359	
B6	-143357.587	-21451.050	-2.291	328432.231817	
C44	-143357.982	-21451.208	-2.097	300621.688254	
C45	-143368.020	-21453.147	-4.404	631392.760080	
C46	-143380.335	-21455.612	-3.166	453942.140610	
C47	-143383.957	-21456.313	-1.077	154424.521689	
C48	-143385.653	-21456.689	-0.959	137506.841227	
C49	-143387.430	-21457.272	-1.199	171921.528570	
C50	-143389.172	-21457.888	-1.461	209491.580292	
C51	-143391.257	-21458.733	-2.106	301981.987242	
C52	-143393.476	-21459.994	-2.183	313027.958108	
C53	-143394.988	-21460.916	-1.953	280050.411564	
C54	-143396.472	-21461.947	-2.298	329525.092656	
C55	-143397.907	-21463.214	-2.630	377136.495410	
C56	-143399.369	-21464.577	-2.435	349177.463515	
C57	-143400.478	-21465.649	-3.606	517102.123668	
C58	-143402.937	-21468.183	-5.049	724041.428913	
C59	-143405.378	-21470.698	-3.842	550963.462276	
C60	-143406.637	-21472.025	-5.034	721909.010658	
C61	-143410.014	-21475.732	-5.361	768821.085054	
C62	-143411.466	-21477.386	-3.105	445292.601930	
C63	-143412.660	-21478.837	-7.015	1006039.809900	
C64	-143417.191	-21484.401	-6.771	971077.800261	
C65	-143418.167	-21485.608	-1.963	281529.861821	
K23	-143418.754	-21486.364	132.781	-19043285.574874	
K16	-143455.798	-21352.827	136.803	-19625183.533794	
C26	-143430.539	-21349.561	0.199	-28542.677261	
C27	-143416.819	-21352.628	-8.053	1154935.643407	
C28	-143412.054	-21357.614	-1.931	276928.676274	
C29	-143385.360	-21354.559	0.170	-24375.511200	
C30	-143379.189	-21357.444	-3.970	569215.380330	
C31	-143371.128	-21358.529	-12.747	1827551.768616	
C32	-143360.886	-21370.191	-24.485	3510191.293710	
C33	-143366.030	-21383.014	-24.573	3522933.455190	
C34	-143369.770	-21394.764	-20.435	2929761.249950	
C35	-143368.616	-21403.449	-12.716	1823075.321056	
C38	-143359.436	-21407.480	-9.866	1414384.195576	
C39	-143356.302	-21413.315	-7.525	1078756.172550	
C37	-143356.001	-21415.005	-3.229	462896.527229	
C36	-143356.272	-21416.544	-10.663	1528607.928336	
C40	-143359.095	-21425.668	-12.907	1850335.839165	
C41	-143353.501	-21429.451	-6.564	940972.380564	
C42	-143349.162	-21432.232	-4.007	574400.092134	
K12	-143341.860	-21433.458	-15.921	2282145.753060	
C43	-143342.783	-21448.153	-14.785	2119323.046655	
合計				-17675.112733	
合計面積				8837.5563665	
地積				8837.55 m <sup>2</sup>	

図面名称	丈量図 (カ)奈良市中山町178番1		
所在	奈良市中山町178番1		
図番	8 / 17	縮尺	1 / 500
平成20年3月11日 作成			
測量・作成者 奈良市秋篠早月町10番10号 三和マンションB-517 土地家屋調査士 中島 俊一			

# 丈量図

9/17

(キ) 奈良市敷島町一丁目566番20

S = 1 / 250

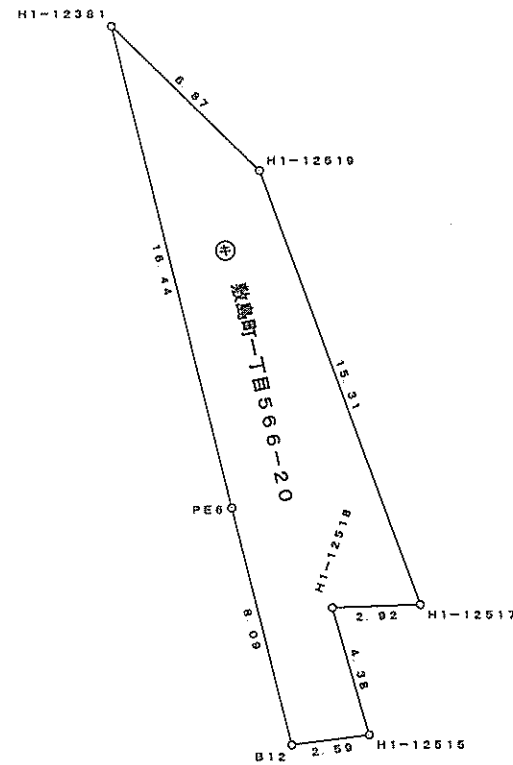
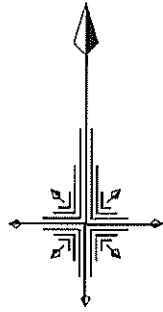

求積表

地番	Ⓚ 敷島町一丁目566-20			
NO	X <sub>n</sub>	Y <sub>n</sub>	Y <sub>n+1</sub> - Y <sub>n-1</sub>	X <sub>n</sub> · (Y <sub>n+1</sub> - Y <sub>n-1</sub> )
H1-12381	-143526.170	-21423.287	-0.907	130178.236190
PE6	-143542.112	-21419.268	6.008	-862401.008896
B12	-143549.960	-21417.279	4.566	-655449.117360
H1-12515	-143549.623	-21414.702	1.346	-193217.792558
H1-12518	-143545.418	-21415.933	1.689	-242448.211002
H1-12517	-143545.309	-21413.013	-2.428	348528.010252
H1-12519	-143530.961	-21418.361	-10.274	1474637.093314
合計				-172.790060
合計面積				86.3950300
地積				86.39 m <sup>2</sup>

図面名称	丈量図 (キ) 奈良市敷島町一丁目566番20		
所在	奈良市敷島町一丁目566番20		
図番	9/17	縮尺	1/250
平成20年3月11日 作成			
測量・作成者 奈良市秋篠早月町10番10号 三和マンションB-517 土地家屋調査士 中島 俊一			

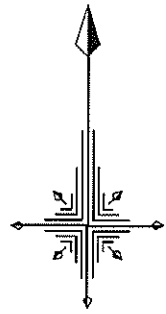

# 丈量図 10/17

(ク) 奈良市敷島町一丁目566番23

S = 1 / 250

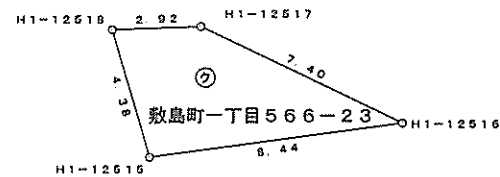

求積表

地番	② 敷島町一丁目566-23			
NO	$X_n$	$Y_n$	$Y_{n+1} - Y_{n-1}$	$X_n \cdot (Y_{n+1} - Y_{n-1})$
H1-12518	-143545.418	-21415.933	-1.689	242448.211002
H1-12515	-143549.623	-21414.702	9.604	-1378650.579292
H1-12516	-143548.486	-21406.329	1.689	-242453.392854
H1-12517	-143545.309	-21413.013	-9.604	1378609.147636
合計				-46.613508
合計面積				23.3067540
地積				23.30 m <sup>2</sup>

図面名称	丈量図 (ク)奈良市敷島町一丁目566番23		
所在	奈良市敷島町一丁目566番23		
図番	10/17	縮尺	1/250
平成20年3月11日 作成			
測量・作成者 奈良市秋篠早月町10番10号 三和マンションB-517 土地家屋調査士 中島 俊一			

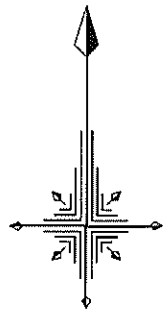

# 丈量図

11/17

(ケ) 里道1

奈良市秋篠町、中山町地内

S = 1 / 500

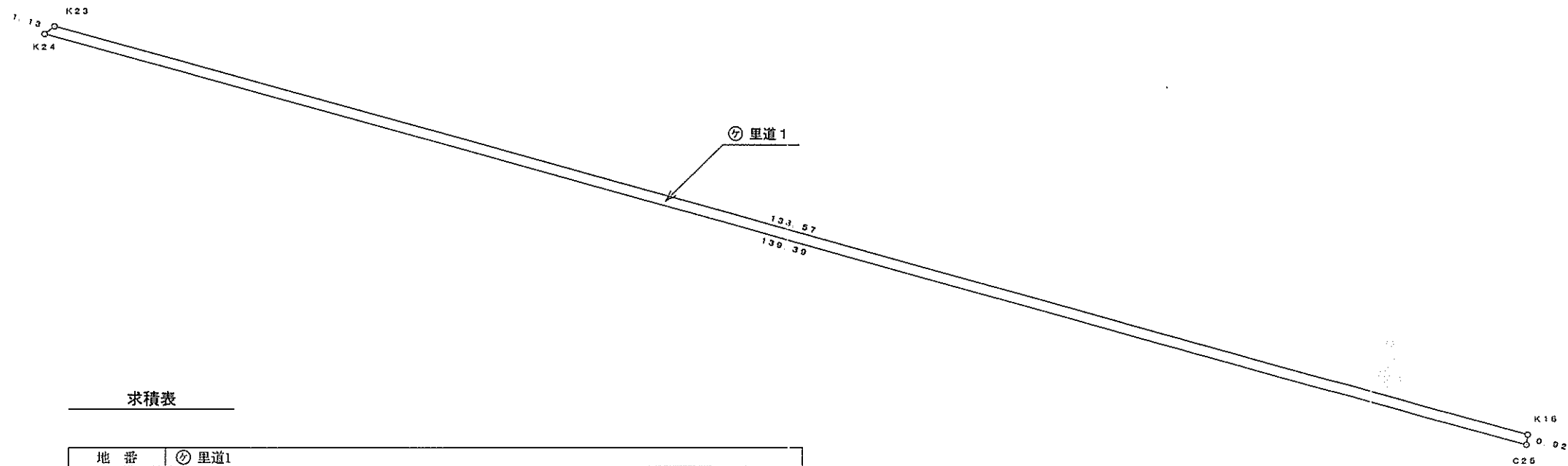

求積表

地番	⊙ 里道1			
NO	X <sub>n</sub>	Y <sub>n</sub>	Y <sub>n+1</sub> - Y <sub>n-1</sub>	X <sub>n</sub> * (Y <sub>n+1</sub> - Y <sub>n-1</sub> )
K23	-143418.754	-21486.364	-134.437	19280787.031498
K24	-143419.453	-21487.264	133.418	-19134736.580354
C25	-143456.715	-21352.946	134.437	-19285890.394455
K16	-143455.798	-21352.827	-133.418	19139585.657564
合計				-254.285747
合計面積				127.1428735
地積				127.14 m <sup>2</sup>

図面名称	丈量図 (ケ)里道1		
所在	奈良市秋篠町、中山町地内		
図番	11/17	縮尺	1/500
平成20年3月11日 作成			
測量・作成者 奈良市秋篠早月町10番10号 三和マンションB-517 土地家屋調査士 中島 俊一			

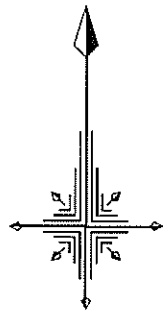

# 丈量図

12/17

(コ) 里道2

奈良市秋篠町、中山町地内

S = 1 / 500

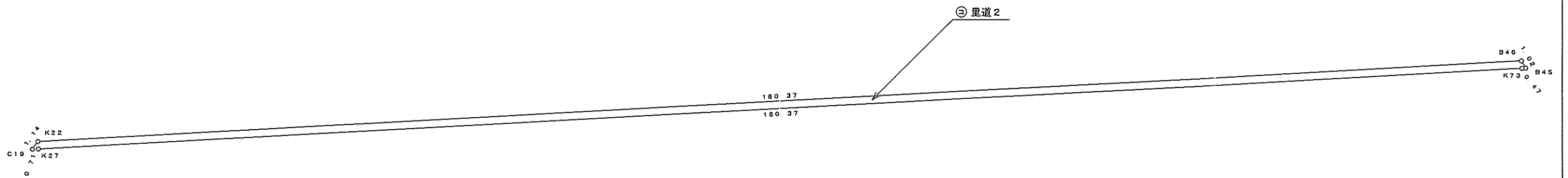

求積表

地番	⊕ 里道2			
NO	X <sub>n</sub>	Y <sub>n</sub>	Y <sub>n+1</sub> - Y <sub>n-1</sub>	X <sub>n</sub> · (Y <sub>n+1</sub> - Y <sub>n-1</sub> )
K22	-143468.962	-21261.284	-180.763	25933879.978006
C19	-143469.891	-21261.950	0.050	-7173.494550
K27	-143469.875	-21261.234	180.813	-25941218.508375
K73	-143459.947	-21081.137	180.572	-25904849.549684
B45	-143459.917	-21080.662	-0.050	7172.995850
B46	-143459.034	-21081.187	-180.622	25911857.639148
合計				-330.939605
合計面積				165.4698025
地積				165.46 m <sup>2</sup>

図面名称	丈量図 (コ)里道2		
所在	奈良市秋篠町、中山町地内		
図番	12/17	縮尺	1/500

平成20年3月11日 作成

測量・作成者

奈良市秋篠早月町10番10号  
三和マンションB-517  
土地家屋調査士 中島 俊一

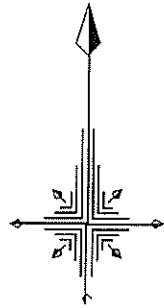

# 丈量図

13 / 17

(サ) 里道3

奈良市中山町地内

S = 1 / 250

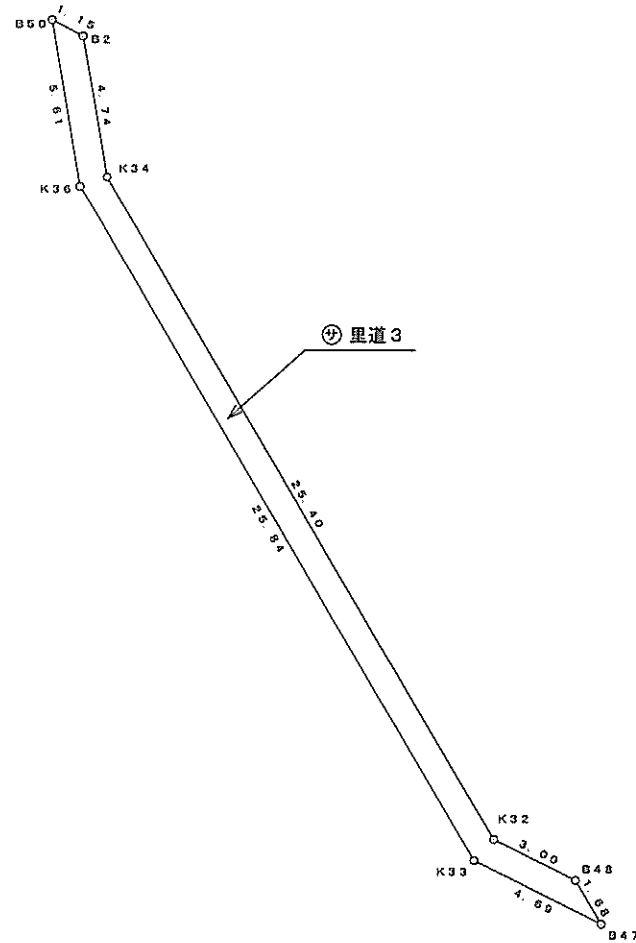

求積表

地番	⊕里道3			
NO	X <sub>n</sub>	Y <sub>n</sub>	Y <sub>n+1</sub> - Y <sub>n-1</sub>	X <sub>n</sub> · (Y <sub>n+1</sub> - Y <sub>n-1</sub> )
B50	-143428.618	-21099.790	-0.070	10040.003260
K36	-143434.147	-21098.840	14.078	-2019265.921466
K33	-143456.412	-21085.712	17.337	-2487103.814844
B47	-143458.499	-21081.503	3.346	-480012.137654
B48	-143457.051	-21082.366	-3.559	510563.644509
K32	-143455.714	-21085.062	-15.602	2238196.049828
K34	-143433.828	-21097.968	-13.708	1966190.914224
B2	-143429.151	-21098.770	-1.822	261327.913122
合計				-63.349021
合計面積				31.6745105
地積				31.67 m <sup>2</sup>

図面名称	丈量図 (サ)里道3		
所在	奈良市中山町地内		
図番	13 / 17	縮尺	1 / 250
平成20年3月11日 作成			
測量・作成者 奈良市秋篠早月町10番10号 三和マンションB-517 土地家屋調査士 中島 俊一			



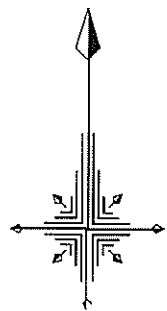

# 丈量図 15 / 17

(ス) 水路1

奈良市秋篠町、中山町地内

S = 1 / 500

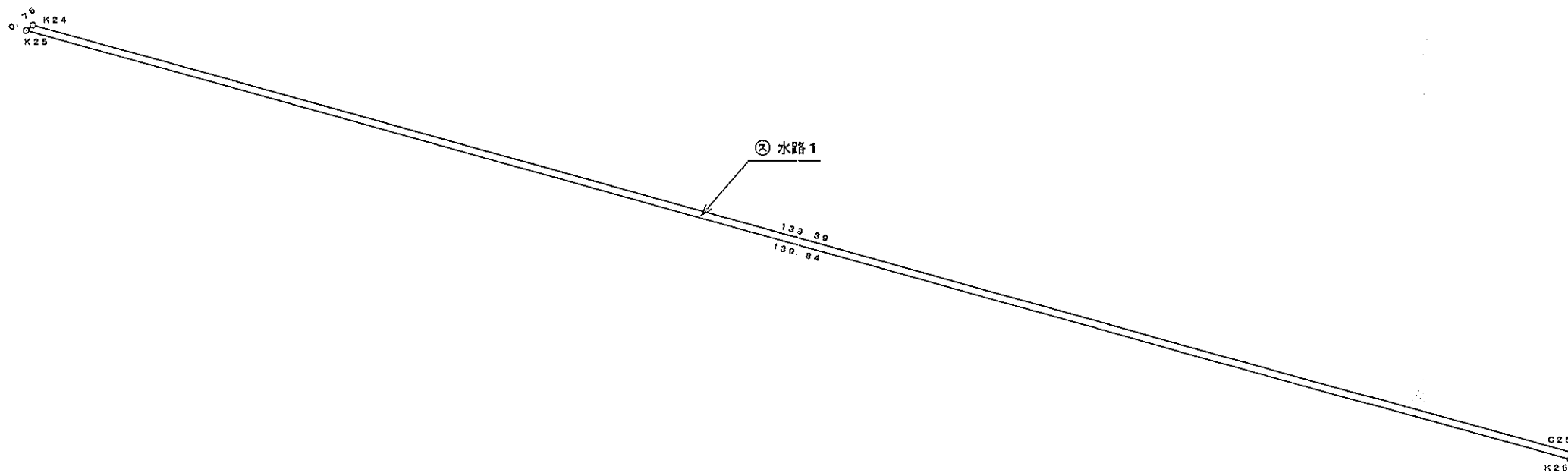

求積表

地番	② 水路1				
NO	$X_n$	$Y_n$	$Y_{n+1} - Y_{n-1}$	$X_n \cdot (Y_{n+1} - Y_{n-1})$	
K24	-143419.453	-21487.264	-134.922	19350439.437666	
K25	-143419.923	-21487.868	134.154	-19240356.350142	
K26	-143457.307	-21353.110	134.922	-19355546.775054	
C25	-143456.715	-21352.946	-134.154	19246292.144110	
合計				-171.543420	
合計面積				85.7717100	
地積				85.77 m <sup>2</sup>	

図面名称	丈量図 (ス) 水路1		
所在	奈良市秋篠町、中山町地内		
図番	15 / 17	縮尺	1 / 500

平成20年3月11日 作成

測量・作成者

奈良市秋篠早月町10番10号  
三和マンションB-517  
土地家屋調査士 中島 俊一

# 丈量図

16 / 17

## (七) 水路2

奈良市秋篠町地内

S = 1 / 250

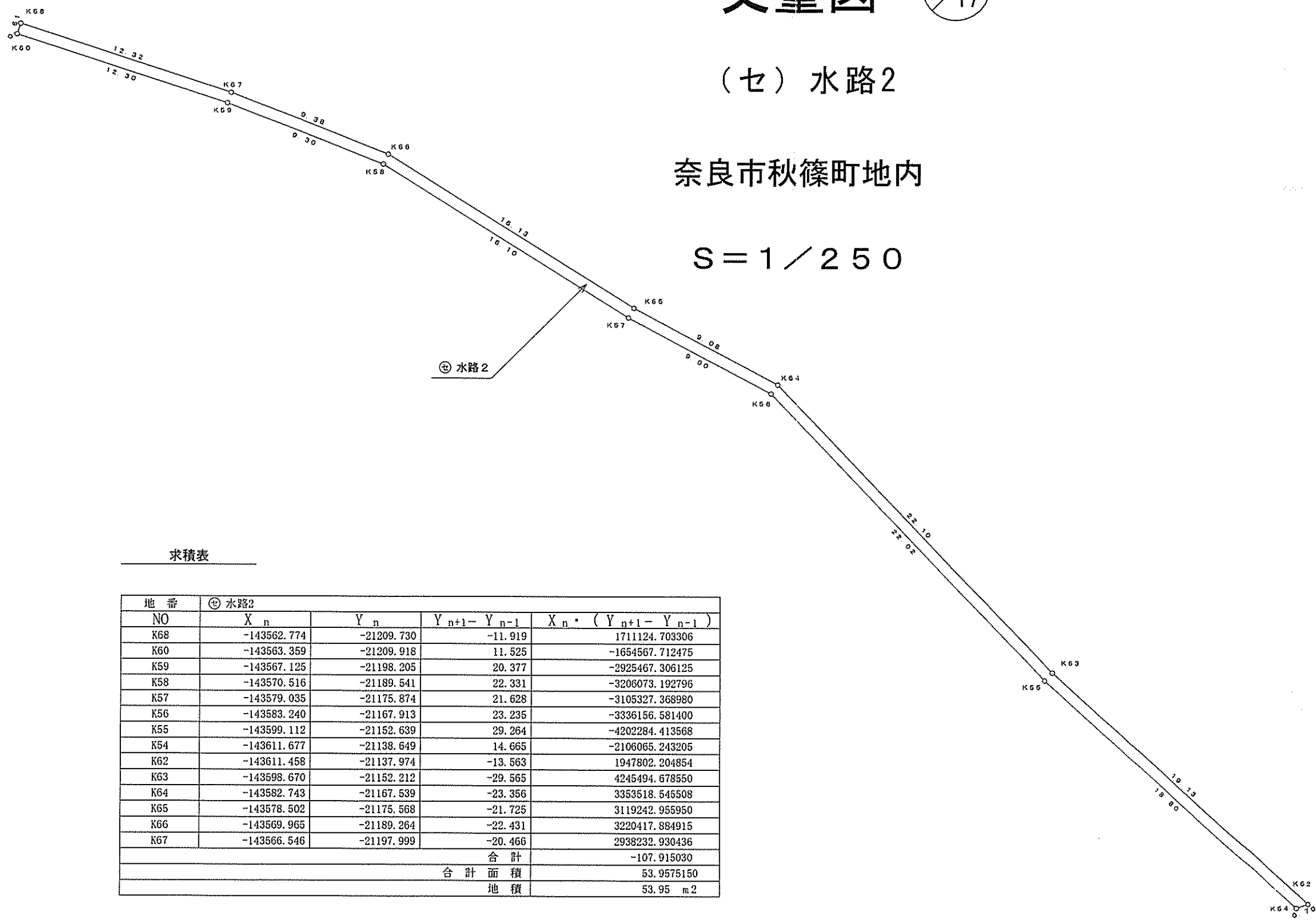
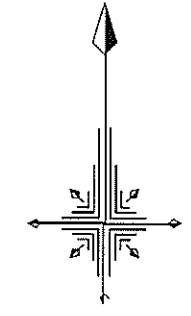

求積表

地番	㊟ 水路2			
NO	$X_n$	$Y_n$	$Y_{n+1} - Y_{n-1}$	$X_n \cdot (Y_{n+1} - Y_{n-1})$
K68	-143562.774	-21209.730	-11.919	1711124.703306
K60	-143563.359	-21209.918	11.525	-1654567.712475
K59	-143567.125	-21198.205	20.377	-2925467.306125
K58	-143570.516	-21189.541	22.331	-3206073.192796
K57	-143579.035	-21175.874	21.628	-3105327.368980
K56	-143583.240	-21167.913	23.235	-3336156.581400
K55	-143599.112	-21152.639	29.264	-4202284.413568
K54	-143611.677	-21138.649	14.665	-2106065.243205
K62	-143611.458	-21137.974	-13.563	1947802.204854
K63	-143598.670	-21152.212	-29.565	4245494.678550
K64	-143582.743	-21167.539	-23.356	3353518.545508
K65	-143578.502	-21175.568	-21.725	3119242.955950
K66	-143569.965	-21189.264	-22.431	3220417.884915
K67	-143566.546	-21197.999	-20.466	2938232.930436
合計				-107.915030
合計面積				53.9575150
地積				53.95 m <sup>2</sup>

図面名称	丈量図 (七) 水路2		
所在	奈良市秋篠町地内		
図番	16 / 17	縮尺	1 / 250
平成20年3月11日 作成			
測量・作成者			
奈良市秋篠早月町10番10号			
三和マンションB-517			
土地家屋調査士 中島 俊一			

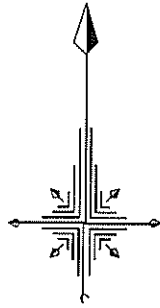

# 丈量図 17/17

(ソ) 水路3

奈良市秋篠町地内

S = 1 / 250

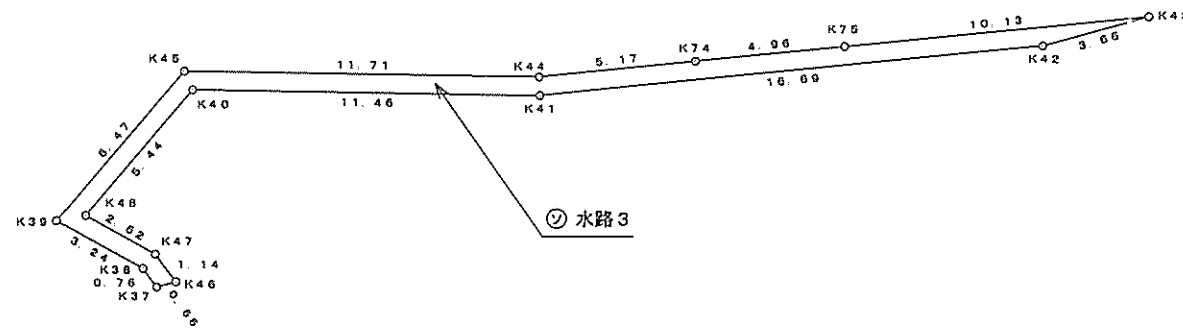

求積表

地番	③ 水路3			
NO	X <sub>n</sub>	Y <sub>n</sub>	Y <sub>n+1</sub> - Y <sub>n-1</sub>	X <sub>n</sub> · (Y <sub>n+1</sub> - Y <sub>n-1</sub> )
K45	-143582.611	-21069.864	-15.895	2282245.601845
K39	-143587.564	-21074.041	-1.333	191402.222812
K38	-143589.133	-21071.197	3.309	-475136.441097
K37	-143589.746	-21070.732	1.102	-158235.900092
K46	-143589.570	-21070.095	-0.054	7753.836780
K47	-143588.658	-21070.786	-2.994	429904.442052
K48	-143587.388	-21073.089	1.205	-173022.802540
K40	-143583.228	-21069.581	14.972	-2149728.089616
K41	-143583.350	-21058.117	28.070	-4030384.634500
K42	-143581.609	-21041.511	20.132	-2890584.952388
K43	-143580.622	-21037.985	-6.555	941170.977210
K75	-143581.679	-21048.066	-15.017	2156166.073543
K74	-143582.196	-21053.002	-10.080	1447308.535680
K44	-143582.735	-21058.146	-16.862	2421092.077570
合計				-49.052741
合計面積				24.5263705
地積				24.52 m <sup>2</sup>

図面名称	丈量図 (ソ) 水路3		
所在	奈良市秋篠町地内		
図番	17/17	縮尺	1/250
平成20年3月11日 作成			
測量・作成者			
奈良市秋篠早月町10番10号			
三和マンションB-517			
土地家屋調査士 中島 俊一			